



mpc
METODICKO-PEDAGOGICKÉ CENTRUM

**VZDELÁVANÍM
PEDAGOGICKÝCH ZAMESTNANCOV
K INKLÚZII MARGINALIZOVANÝCH
RÓMSKYCH KOMUNIT**



Moderné vzdelávanie pre vedomostnú spoločnosť / Projekt je spolufinancovaný zo zdrojov EÚ

Kód ITMS: 26130130051

číslo zmluvy: OPV/24/2011

Metodicko – pedagogické centrum

Národný projekt

**VZDELÁVANÍM PEDAGOGICKÝCH ZAMESTNANCOV
K INKLÚZII MARGINALIZOVANÝCH RÓMSKYCH KOMUNIT**

Marta Beňková

Meine Schulsachen (Neutrum)

Vydavateľ: Metodicko-pedagogické centrum,
Ševčenkova 11, 850 01 Bratislava
Autor UZ: PaedDr. Marta Beňková
Kontakt na autora UZ: Základná škola, Kúpeľná 2, 080 01
Prešov
skola@zskuppo.sk
Názov: Meine Schulsachen (Neutrum)
Rok vytvorenia: 2014
Oponentský posudok vypracoval: RNDr. Peter Dolíhal
ISBN 978-80-565-0812-1

Tento učebný zdroj bol vytvorený z prostriedkov projektu Vzdelávaním pedagogických zamestnancov k inklúzii marginalizovaných rómskych komunít. Projekt je spolufinancovaný zo zdrojov Európskej únie.

Text neprešiel štylistickou ani grafickou úpravou.

OBSAH

Úvod.....	4
1) Meine Schulsachen (Neutrum).....	5
2) Wortschatz.....	6
3) Was passt zusammen?.....	8
4) Lies und schreib!.....	11
5) Schreib die Wörter richtig!.....	13
6) Ergänze es richtig!.....	15
7) Memory.....	17
8) Suche die Schulsachen!.....	18
9) Male die Bilder aus!.....	19
Literatúra.....	22

ÚVOD

Metodická poznámka:

Prvý pracovný list (s. 5) je možné použiť v rámci motivačného rozhovoru v úvode vyučovacej hodiny na to, aby žiaci porozumeli rozdiely v rodoch v jednotlivých jazykoch (slovenský, ukrajinský, rusínsky, rómsky, nemecký).

1) MEINE SCHULSACHEN (NEUTRUM) / MOJE ŠKOLSKÉ POMÔCKY (STREDNÝ ROD)

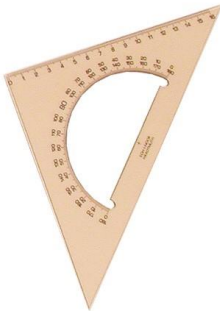
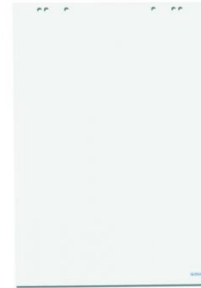
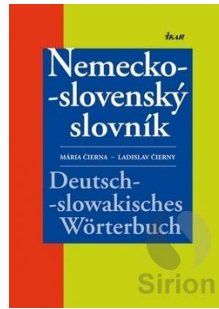
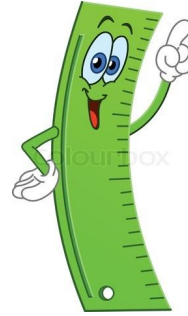

2) WORTSCHATZ / SLOVNÁ ZÁSoba



das Buch - kniha



das Heft - zošit



das Lineal - pravítko



das Etui - peračník

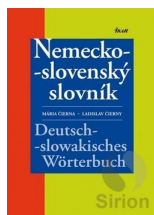

das Wörterbuch - slovník

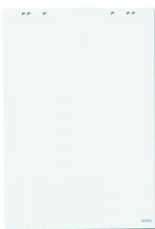

das Blatt Papier - list papiera

WORTSCHATZ / SLOVNÁ ZÁSoba

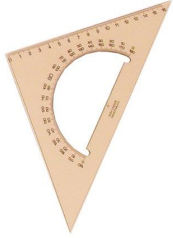

das Dreieck - pravítko



das Turnzeug - telocvičný úbor



das Bildchen - obrázok



das Notebook - notebook



das Abspielgerät - prehrávač



das Mikroskop - mikroskop

3) WAS PASST ZUSAMMEN? / ČO PATRÍ K SEBE?



das Lineal



das Etui



das Heft



das Buch

WAS PASST ZUSAMMEN? / ČO PATRÍ K SEBE?

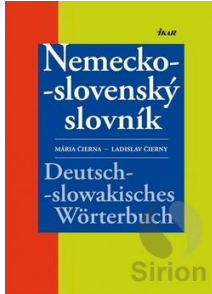

das Turnzeug

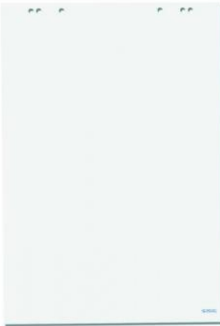

das Dreieck

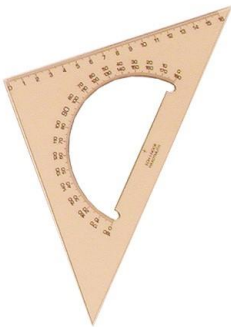

das Blatt Papier



das Wörterbuch

WAS PASST ZUSAMMEN? / ČO PATRÍ K SEBE?



das Abspielgerät





das Mikroskop



das Bildchen



das Notebook

4) LIES UND SCHREIB! / ČÍTAJ A NAPIŠ!  



1) Das ist



2) Das ist



3) Das ist



4) Das ist



5) Das ist

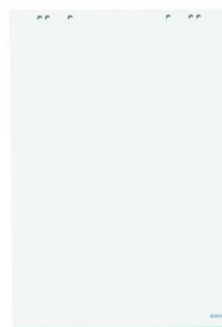

6) Das ist

LIES UND SCHREIB! / ČÍTAJ A NAPIŠ!  

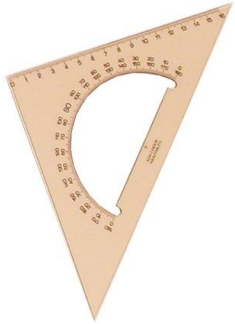

7) Das ist

8) Das ist



9) Das ist

10) Das ist



11) Das ist

12) Das ist

5) SCHREIB DIE WÖRTER RICHTIG! / NAPÍŠ SLOVÁ SPRÁVNE!

chbu

.....

tefh

.....

nelila

.....

talbt ierpap

.....

uite

.....

ieckred

.....

SCHREIB DIE WÖRTER RICHTIG! / NAPÍŠ SLOVÁ SPRÁVNE!

terröwchub

.....

runtgezu

.....

chenlibd

.....

bokoteno

.....

krospokim

.....

tärliepgesab

.....

6) ERGÄNZE ES RICHTIG! / DOPLŇ SPRÁVNE! ✍



das _ _ ch



das _ e _ t



das L _ _ e _ _



das _ t _ i



das _ ö _ _ e _ b _ ch

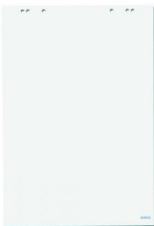

das _ l _ _ t P _ _ i e _

ERGÄNZE ES RICHTIG! / DOPLŇ SPRÁVNE! ✍

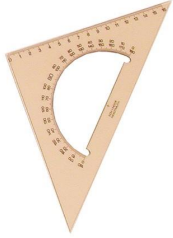

das D__i__c__



das _u__z__g



das _i__c__h__n



das N__e__o__k



das _b__i__e__g__r__t



das M__k__s__o__

7) MEMORY / PEXESO ✂

	<p>das Buch</p>		<p>das Dreieck</p>
	<p>das Heft</p>		<p>das Turnzeug</p>
	<p>das Lineal</p>		<p>das Bildchen</p>
	<p>das Etui</p>		<p>das Notebook</p>
	<p>das Wörterbuch</p>		<p>das Abspielgerät</p>
	<p>das Blatt Papier</p>		<p>das Mikroskop</p>

8) SUCHE DIE SCHULSACHEN! / HĽADAJ ŠKOLSKÉ POMÔCKY!

Hier sind 12 Wörter versteckt. Notier die Wörter mit dem Artikel! / Je tu ukrytých 12 slov.

Zapíš ich s členom! (pozn. ö = oe, ä = ae)

B	U	C	H	A	S	D	F	H	E	F	T	G	J	K	E
Y	L	I	N	E	A	L	U	G	U	E	Z	N	R	U	T
B	L	A	T	T	P	A	P	I	E	R	G	H	J	K	U
V	B	N	M	D	F	G	J	K	C	E	I	E	R	D	I
B	I	L	D	C	H	E	N	D	F	G	H	J	K	L	G
I	K	J	H	G	F	D	S	A	W	E	R	Y	U	I	O
V	F	G	J	N	O	T	E	B	O	O	K	T	Y	U	I
T	E	A	R	E	G	L	E	I	P	S	B	A	N	M	F
C	V	B	N	M	M	I	K	R	O	S	K	O	P	T	Y
W	O	E	R	T	E	R	B	U	C	H	N	M	H	G	F

.....**das**...Abspielgerät.....

9) MALE DIE BILDER AUS! / VYMAĽUJ OBRÁZKY! ✍️

1) Das Buch ist rot.

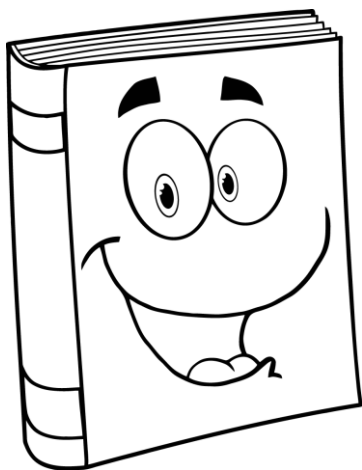

2) Das Heft ist grün.

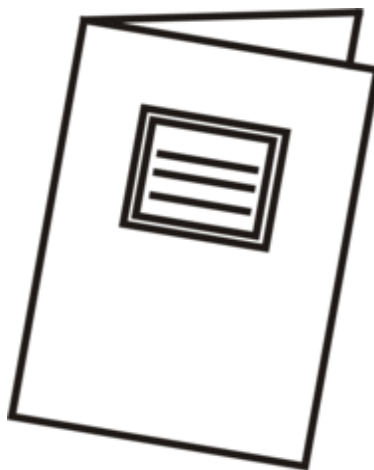

3) Das Lineal ist lila.

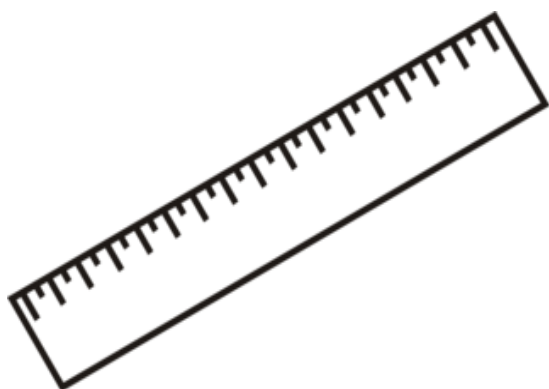

4) Das Etui ist bunt.

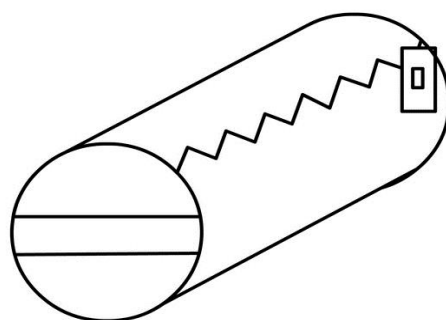

MALE DIE BILDER AUS! / VYMAĽUJ OBRÁZKY! ✍️

5) Das Wörterbuch ist rosa.

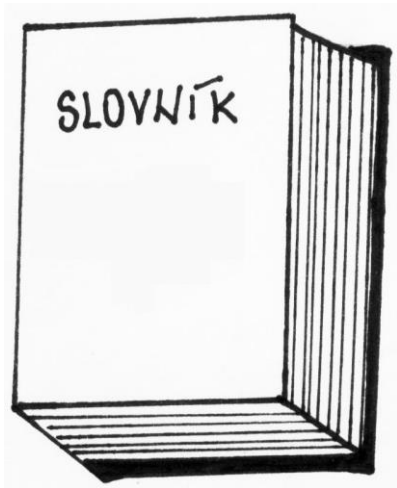

6) Das Blatt Papier ist orange.

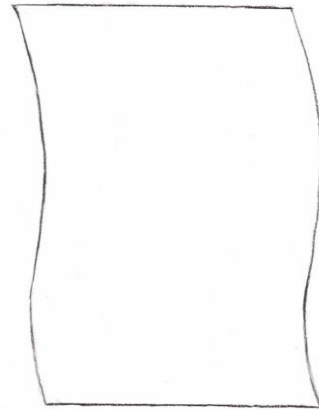

7) Das Dreieck ist gelb.



8) Das Turnzeug ist rot.

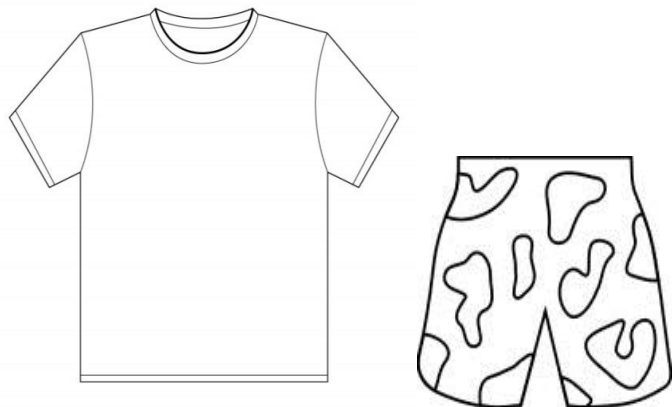

MALE DIE BILDER AUS! / VYMAĽUJ OBRÁZKY! ✍

9) Das Bildchen ist farbig.

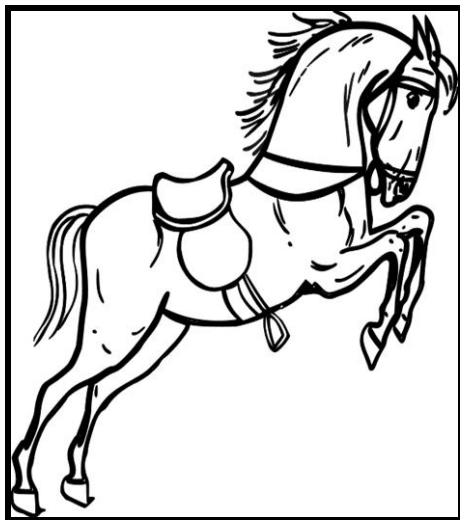

10) Das Notebook ist schwarz.



11) Das Abspielgerät ist grau.

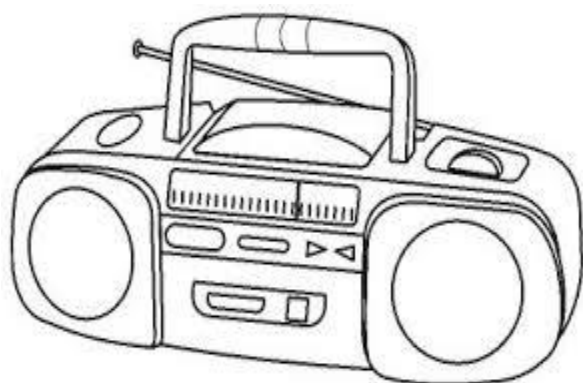

12) Das Mikroskop ist silbern.

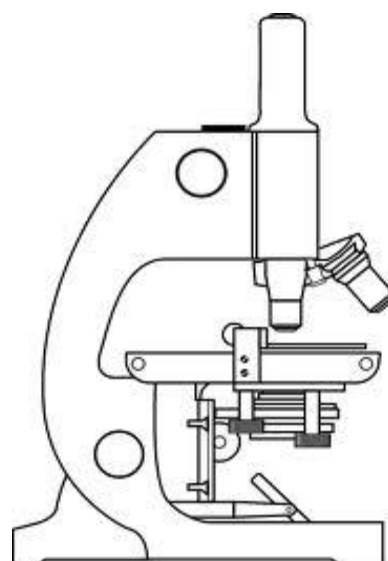

LITERATÚRA

<http://www.schaebenschreibt.de/wp-content/uploads/2013/10/Ghostwriter-Holger-Schaeben-Buch.jpg>

http://www.prokind.de/kinder/ausmalbilder/bilder/gif_5187-Text-Book-Cartoon-Mascot-Character-Royalty-Free-RF-Clipart-Image.gif

http://www.pagro.at/media/catalog/product/cache/1/small_image/115x150/9df78eab33525d08d6e5fb8d27136e95/P/_P_106678_A5_20_lin10.jpg

http://media.4teachers.de/images/thumbs/image_thumb.560.png

<http://www.colourbox.com/preview/3461025-873238-cartoon-ruler-pointing-with-his-finger.jpg>

http://media.4teachers.de/images/thumbs/image_thumb.556.png

http://www.coopydoo.sk/sub/coopydoo.sk/images/shop-active-images/domacnost/trojvrstvovy-detsky-peracnik_426.jpg

<http://wiki.rvp.cz/@api/deki/files/15819/=pouzdro.jpg>

http://www.sirion.sk/user/catalog_big/184/nemecko-slovensky-slovník-deutsch-slowakisches-worterbuch.jpg

http://gymal.edupage.org/files/Slovník_cudzich_slov_4.jpg

<http://www.ofisprofis.sk/6432-thickbox/flipchartovy-papier-cisty-20-listov.jpg>

<http://tabor.ywam.sk/2009/images/papier2.jpg>

<http://shop.regina.sk/Portal/Images/share5/pravitko-uhlomer.jpg>

<http://shop.regina.sk/Portal/Images/share5/pravitko-ryska.jpg>

<http://www.pascogifts.com/frontend/files/products/images/source/striker-cool-fit-sport-t-shirt-dc89.jpg>

<http://im9.cz/sk/iR/importprodukt-orig/d38/d386781051e11807587fe4ff39dbf5d3--mmf150x150.jpg>

http://www.zeitgeistmovement.sk/www/media/kunena/attachments/179/t_shirt_template.jpg

<http://omalovanky.luksoft.cz/nahled-maly/kratasy.jpg>

<http://www.klkone.estranky.cz/img/mid/100/obrazky-koni-19.jpg>

<http://omalovanky.luksoft.cz/1280/hrebec.jpg>

http://regmedia.co.uk/2012/08/23/acer_aspire_5733_15in_notebook.jpg

http://www.learnersdictionary.com/media/ld/images/legacy_print_images/laptop.gif

<http://www.shark.sk/obrazky/58684/prehravac-sony-s-cd-mp3-fm-am-na-siet-a-na-baterie-original.jpg>

http://lh3.ggpht.com/-iIsdm-uyIZU/TID0y1yzuvI/AAAAAAAAAFD0/XruM_Kr_UtA/s160-c/34.JPG

<http://www.meraj.sk/tovar/1275-1.jpg>

<http://www.clker.com/cliparts/z/b/X/d/u/C/mikroskop-3.svg>