



mpc
METODICKO-PEDAGOGICKÉ CENTRUM

**VZDELÁVANÍM
PEDAGOGICKÝCH ZAMESTNANCOV
K INKLÚZII MARGINALIZOVANÝCH
RÓMSKYCH KOMUNIT**



Moderné vzdelávanie pre vedomostnú spoločnosť / Projekt je spolufinancovaný zo zdrojov EÚ

Kód ITMS: 26130130051

číslo zmluvy: OPV/24/2011

Metodicko – pedagogické centrum

Národný projekt

**VZDELÁVANÍM PEDAGOGICKÝCH ZAMESTNANCOV
K INKLÚZII MARGINALIZOVANÝCH RÓMSKYCH KOMUNIT**

Marta Beňková

Meine Schulsachen (Maskulinum)

Vydavateľ: Metodicko-pedagogické centrum,
Ševčenkova 11, 850 01 Bratislava
Autor UZ: PaedDr. Marta Beňková
Kontakt na autora UZ: Základná škola, Kúpeľná 2, 080 01
Prešov
skola@zskuppo.sk
Názov: Meine Schulsachen (Maskulinum)
Rok vytvorenia: 2014
Oponentský posudok vypracoval: RNDr. Peter Dolíhal
ISBN 978-80-565-0810-7

Tento učebný zdroj bol vytvorený z prostriedkov projektu Vzdelávaním pedagogických zamestnancov k inklúzii marginalizovaných rómskych komunít. Projekt je spolufinancovaný zo zdrojov Európskej únie.

Text neprešiel štylistickou ani grafickou úpravou.

OBSAH

Úvod.....	4
1) Meine Schulsachen (Maskulinum).....	5
2) Wortschatz.....	6
3) Was passt zusammen?.....	8
4) Lies und schreib!.....	11
5) Schreib die Wörter richtig!.....	13
6) Ergänze es richtig!.....	15
7) Memory.....	17
8) Suche die Schulsachen!.....	18
9) Male die Bilder aus!.....	19
Literatúra.....	22

ÚVOD

Metodická poznámka:

Prvý pracovný list (s. 5) je možné použiť v rámci motivačného rozhovoru v úvode vyučovacej hodiny na to, aby žiaci porozumeli rozdiely v rodoch v jednotlivých jazykoch (slovenský, ukrajinský, rusínsky, rómsky, nemecký).

1) MEINE SCHULSACHEN (MASKULINUM) / MOJE ŠKOLSKÉ POMÔCKY (MUŽSKÝ ROD)

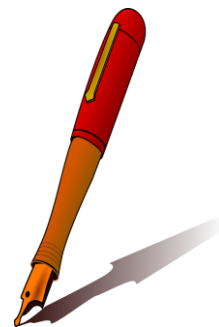

2) WORTSCHATZ / SLOVNÁ ZÁSoba



der Bleistift - ceruza



der Farbstift - farbička



der Filzstift - fixa



der Radiergummi - guma



der Spitzer - strúhadlo

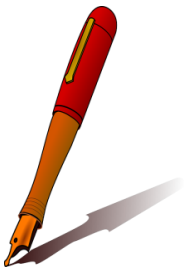

der Füller - plniace pero

WORTSCHATZ / SLOVNÁ ZÁSoba



der Pinsel - štetec



der Malkasten - vodové farby



der Zirkel - kružidlo



der Globus - glóbus



der Block - poznámkový blok



der Taschenrechner - kalkulačka

3) WAS PASST ZUSAMMEN? / ČO PATRÍ K SEBE?



der Taschenrechner



der Globus



der Malkasten



der Zirkel

WAS PASST ZUSAMMEN? / ČO PATRÍ K SEBE?



der Bleistift

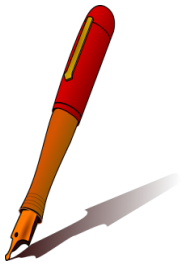

der Block



der Pinsel



der Füller

WAS PASST ZUSAMMEN? / ČO PATRÍ K SEBE?



der Farbstift





der Filzstift



der Spitzer



der Radiergummi

4) LIES UND SCHREIB! / ČÍTAJ A NAPIŠ!  



1) Das ist



2) Das ist



3) Das ist



4) Das ist



5) Das ist



6) Das ist

LIES UND SCHREIB! / ČÍTAJ A NAPIŠ! 🗨️ ✍️



7) Das ist



8) Das ist

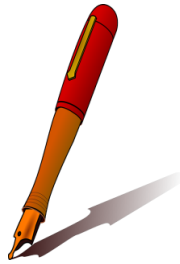

9) Das ist



10) Das ist



11) Das ist



12) Das ist

5) SCHREIB DIE WÖRTER RICHTIG! / NAPÍŠ SLOVÁ SPRÁVNE!

chnerenreschat

.....

losubg

.....

lerizk

.....

tifteisbl

.....

lürelf

.....

inlesp

.....

SCHREIB DIE WÖRTER RICHTIG! / NAPÍŠ SLOVÁ SPRÁVNE!

saktenlam

.....

ilzistftf

.....

colkb

.....

reztisp

.....

diermimurag

.....

fitrafsbt

.....

6) ERGÄNZE ES RICHTIG! / DOPLŇ SPRÁVNE! ✍



der _l__s__f__



der __r__s__i__



der F__z__t



der __d__g__m__



der S____e__

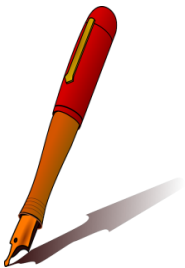

der _ü__e__

ERGÄNZE ES RICHTIG! / DOPLŇ SPRÁVNE! ✍



der _i_s__



der M__k___e__



der _i_k_e__



der _l_o_u__













der _l_c__

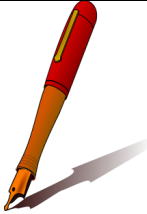

der __s ch__r ch___

7) MEMORY / PEXESO ✂

	der Bleistift		der Farbstift
	der Filzstift		der Radiergummi
	der Spitzer		der Füller
	der Pinsel		der Malkasten
	der Zirkel		der Globus
	der Block		der Taschenrechner

8) SUCHE DIE SCHULSACHEN! / HĽADAJ ŠKOLSKÉ POMÔCKY!

Hier sind 12 Wörter versteckt. Notier die Wörter mit dem Artikel! / Je tu ukrytých 12 slov.

Zapíš ich s členom! (pozn. ü = ue)

T	A	S	C	H	E	N	R	E	C	H	N	E	R
S	P	I	T	Z	E	R	R	U	B	Z	A	M	B
F	A	R	B	S	T	I	F	T	H	I	F	A	L
L	J	G	H	G	F	D	S	A	P	R	U	L	E
F	I	L	Z	S	T	I	F	T	I	K	E	K	I
I	E	O	R	I	P	E	D	S	N	E	L	A	S
K	R	B	L	O	C	K	S	F	S	L	L	S	T
N	Y	U	G	H	J	L	D	M	E	A	E	T	I
V	I	S	E	W	T	Y	S	V	L	E	R	E	F
R	A	D	I	E	R	G	U	M	M	I	A	N	T

.....[der](#)...Füller.....

.....

.....

.....

9) MALE DIE BILDER AUS! / VYMAĽUJ OBRÁZKY!

1) **Der** Bleistift ist gelb.

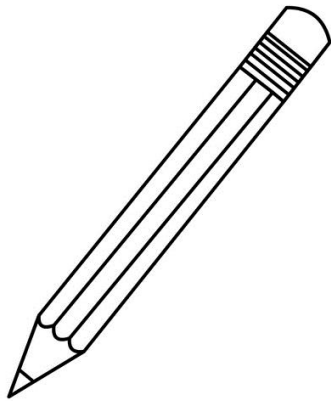

2) **Der** Farbstift ist braun.



3) **Der** Filzstift ist rot.

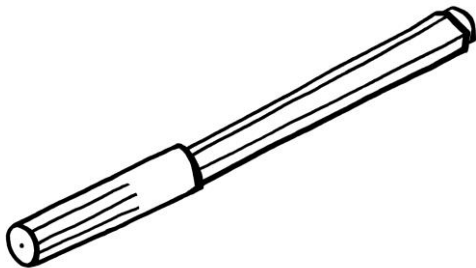

4) **Der** Radiergummi ist azurblau.

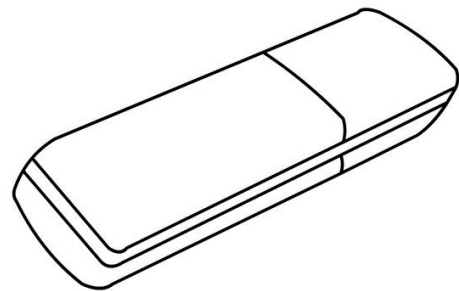

MALE DIE BILDER AUS! / VYMAĽUJ OBRÁZKY!

5) Der Spitzer ist grün.

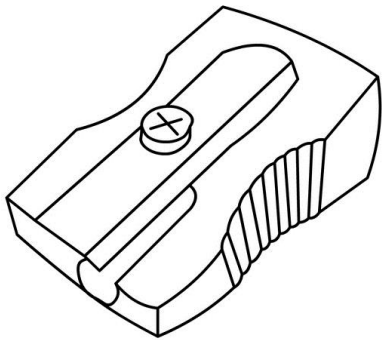

6) Der Block ist grau.

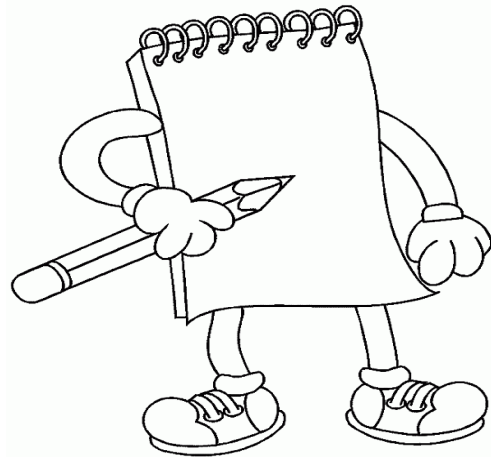

7) Der Füller ist rosa.

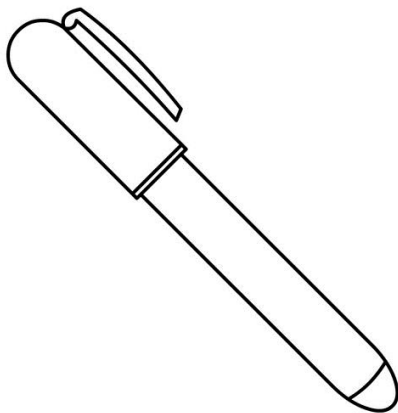

8) Der Pinsel ist blau.

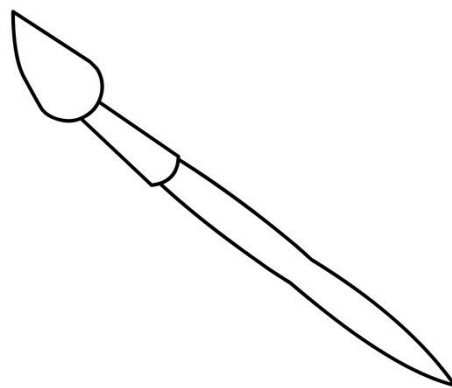

MALE DIE BILDER AUS! / VYMAĽUJ OBRÁZKY!

9) Der Malkasten ist farbig.

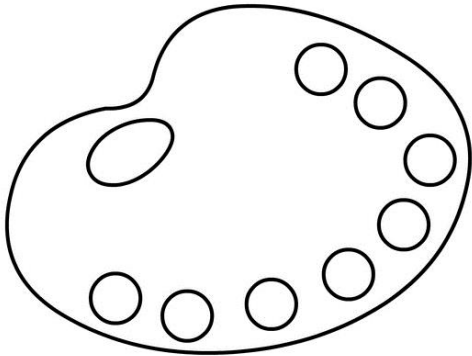

10) Der Zirkel ist lila.

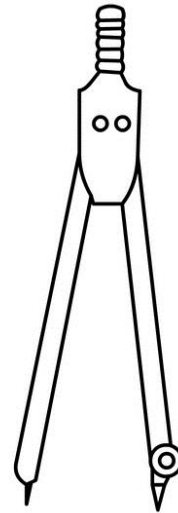

11) Der Taschenrechner ist schwarz.

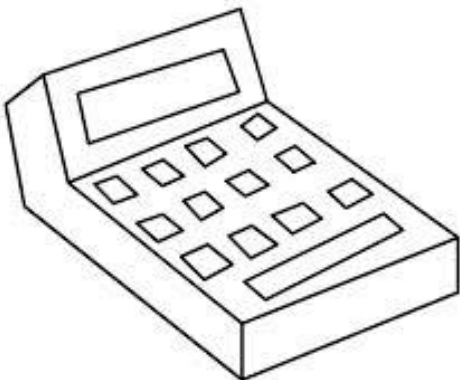

12) Der Globus ist bunt.



LITERATÚRA

http://4.bp.blogspot.com/_pHfsk7ExMQA/S3GDnydzLvI/AAAAAAAAACpw/cpRmWnHPb7w/s1600/pencil.png

<http://wiki.rvp.cz/@api/deki/files/15831/=tu%C5%BEka.jpg?size=webview>

http://www.sevtprerodinu.sk/media/catalog/product/cache/3/image/650x650/9df78eab33525d08d6e5fb8d27136e95/7/s/7s_103_0el.jpg

<http://www.omalovankyvytisknuti.info/wp-content/gallery/Skola/pastelka.jpg>

<http://optickepristroje.cz/367-1026-thickbox/fixka-staedtler-cervena.jpg>

<http://wiki.rvp.cz/@api/deki/files/17713/=fixa.jpg>

http://www.mindenamiroda.hu/img/normal/donau-radir_kombinalt_donau-30839.jpg

<http://wiki.rvp.cz/@api/deki/files/15797/=guma.jpg>

http://www.naradie1.sk/bmz_cache/c/c67c9d9c9b20afa033427d72ac13646b.image.550x550.jpg

<http://wiki.rvp.cz/@api/deki/files/15825/=strouh%C3%A1tko.jpg?size=webview>

<http://www.imitrade.sk/data/foto2/rozmer-2/B4001600PB2.jpg>

<http://www.omalovankyvytisknuti.info/wp-content/gallery/Skola/blok.gif>

http://pixabay.com/static/uploads/photo/2012/04/13/19/25/red-33360_640.png

<http://wiki.rvp.cz/@api/deki/files/15817/=pero.jpg>

<http://upload.wikimedia.org/wikipedia/commons/4/4b/Stock-brush-2.png>

<http://wiki.rvp.cz/@api/deki/files/15827/=%C5%A1t%C4%9Btec.jpg?size=webview>

http://www.berinjela-shop.sk/user/322/upload/stuff/resized/1424544_230-230-true.jpg

<http://wiki.rvp.cz/@api/deki/files/15813/=paleta.jpg?size=webview>

http://img.datacomp.sk/kalkulacka-stolna-casio-ms-100ter_i50420.jpg

<http://wiki.rvp.cz/@api/deki/files/15799/=kalkula%C4%8Dka.jpg?size=webview>

http://www.papirnictvipavlik.cz/galerie/1_679/kruzitko-kovove-s-kloubem-original.jpg

<http://wiki.rvp.cz/@api/deki/files/15803/=kru%25c5%25be%25c3%25adt%25ko.jpg>

<http://www.skolni-potreby.eu/fotografie/max/globus-svitici-orion-skolni-25-cm-83610-0.jpg>

<http://www.animaatjes.nl/kleurplaten/tv-series-kleurplaten/het-programma-met-de-muis/animaatjes-het-programma-met-de-muis-19057.gif>